

order number: 481A42

BalanceBox®
HEIGHT ADJUSTABLE MOUNTS

Floorsupport
For the BalanceBox®400 and 400H

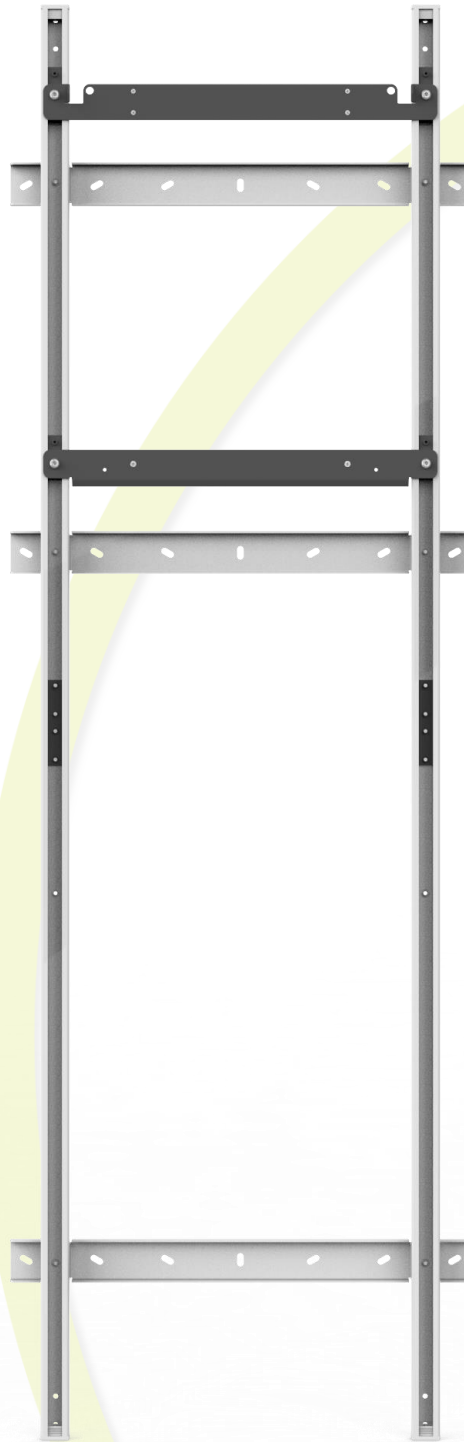

Installation manual

Part nr. 902828-03

Floorsupport

For the BalanceBox®400 and 400H

The contents of the box

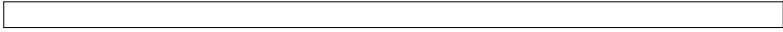

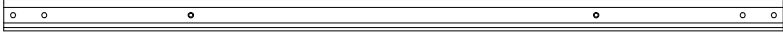

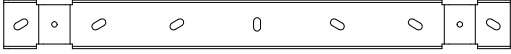

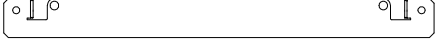

A:4x 

B:4x 

C:3x 

D:1x 

E:1x 



F:2x         

G:4x H:4x I:12x J:12x K:4x L:4x M:14X N:2X

Safety Instructions



Tools needed

1 Assemble legs

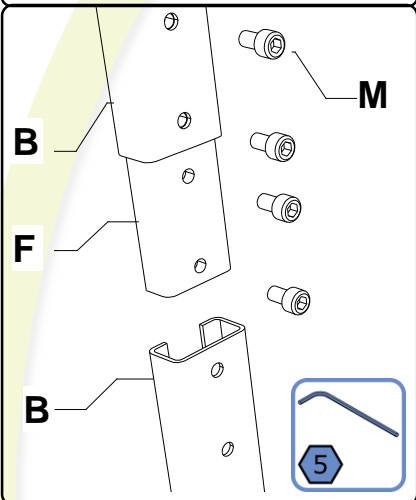

2 Assemble 3x

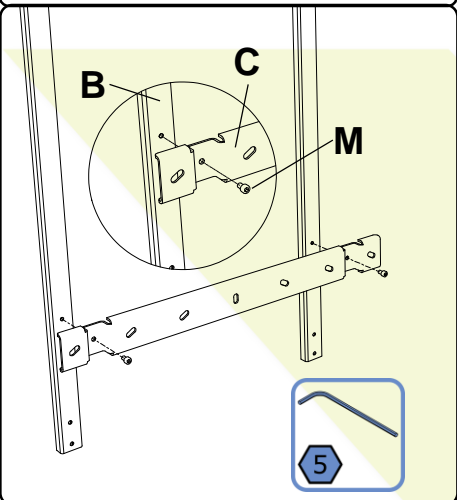

3 Assemble 4x

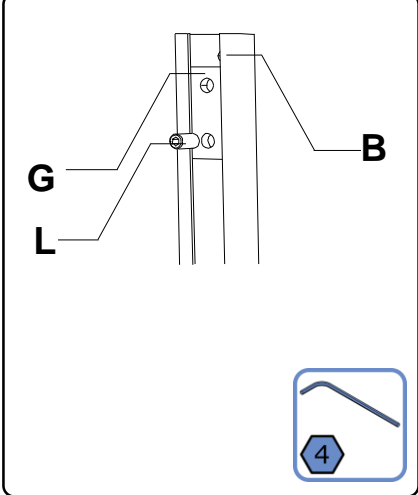

4 Set height and align top level

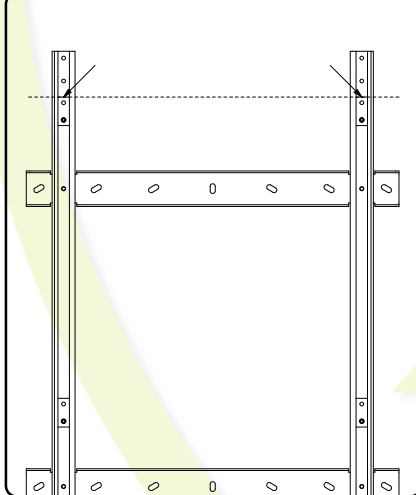

5 Measure **518 mm / 20³/₈"** and fix (● 4 mm)

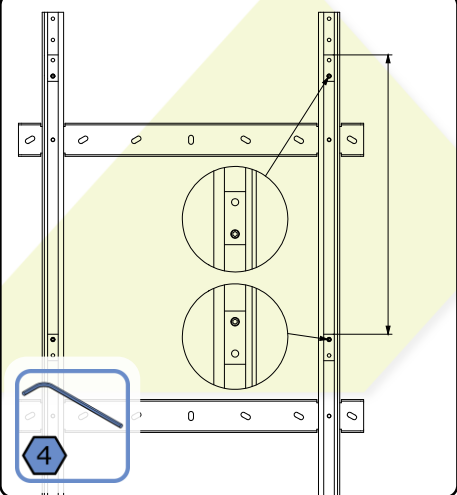

6 Assemble
Top and Bottom 4x

7 Fix 3 brackets to the wall
*Fasteners not included

! Min. 2 screws per bracket !

8 Fix TOP bracket

9 Fix BOTTOM bracket

10 Hang BalanceBox®400 (*) and fix 2x at bottom.
Use screw 2x M6x35 and 2x M6 washer (● 5 mm)

*Please refer to the
BalanceBox®
Installation Manual

11 Mount cover strips (4x)
Snap into leg B

Cut top cover strip to length
if needed, cut and snap off

Important:

When mounting on studded plastered drywalls always mount to the studs in the wall.

(common stud distances shown in the sketch)
Use minimum 2 fixation points per bracket.

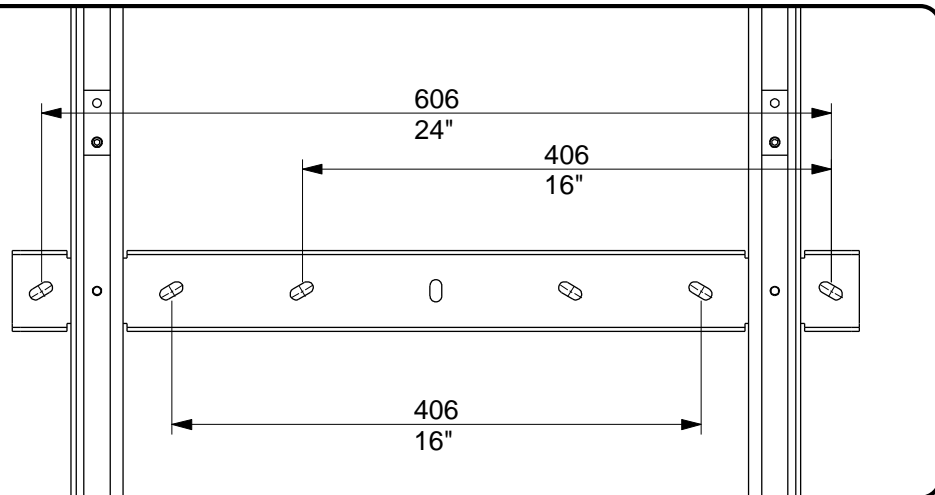

WALL TYPE

ADVISED MOUNTING HARDWARE

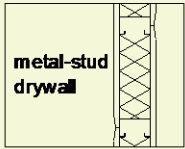
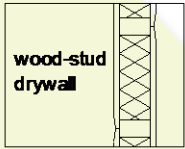
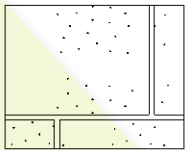
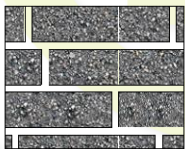
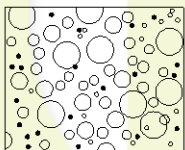

Fischer UX 10 mm
Wurth Master 10 mm

DIN 571 8 x 70 mm.
diam. 5/16" x 3"

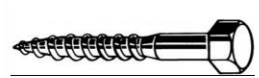

DIN 571 8 x 70 mm.
diam. 5/16" x 3"



Toggler Snaptoggle BE
diam. M8 or 5/16" - 18